

Control Joint Section View (2")

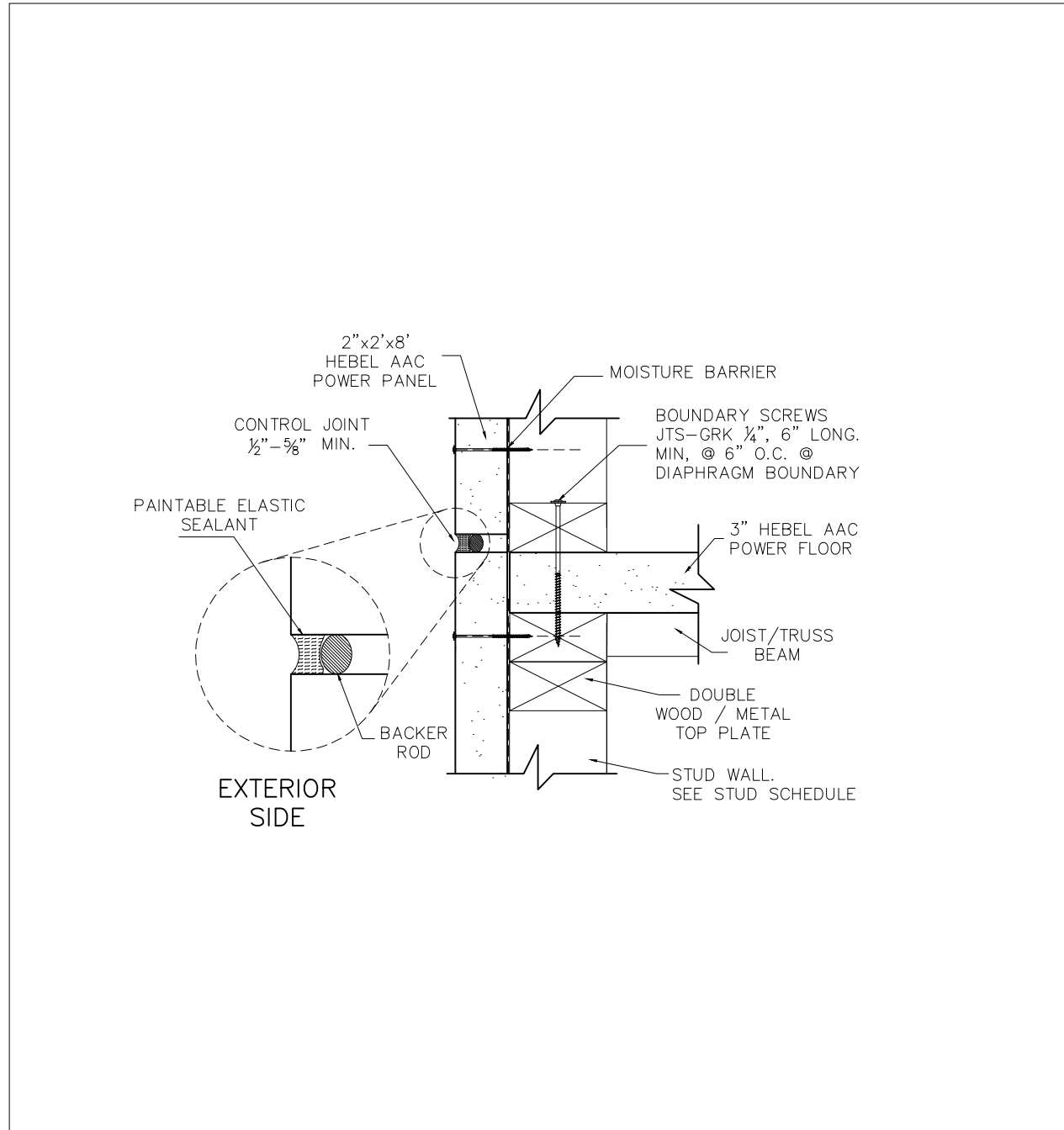

NOTES

- 1.-NOT SCALE.
- 2.-DIMENSIONS INCHES.
- 3.-STEEL REINFORCEMENT IN POWER PANEL FY=70 ksi
- 4.- AAC STRENGTH CLASS AAC-4/500- F'aac= 580 psi.

- 5.- CONTROL JOINTS TO BE LOCATED MAX. @ 20' HORIZONTALLY AND VERTICALLY.
- 6.- CONTROL JOINTS TO BE FILLED WITH BACKER ROD AND PAINTABLE ELASTIC SEALANT.

LITECRETE, S.A. DE C.V.

Río Amacuzac #1201 Ote. ■ Col. Valle Oriente ■ San Pedro Garza García, N.L. ■ México ■ 66269

Tel. +52 (81)8399-2464 +52 (81)8399-2462 Fax +52 (81)8399-2420

www.hebel.mx

September 2020