

Interfloor Framing Connection Detail Typ. Block-Studs (3")

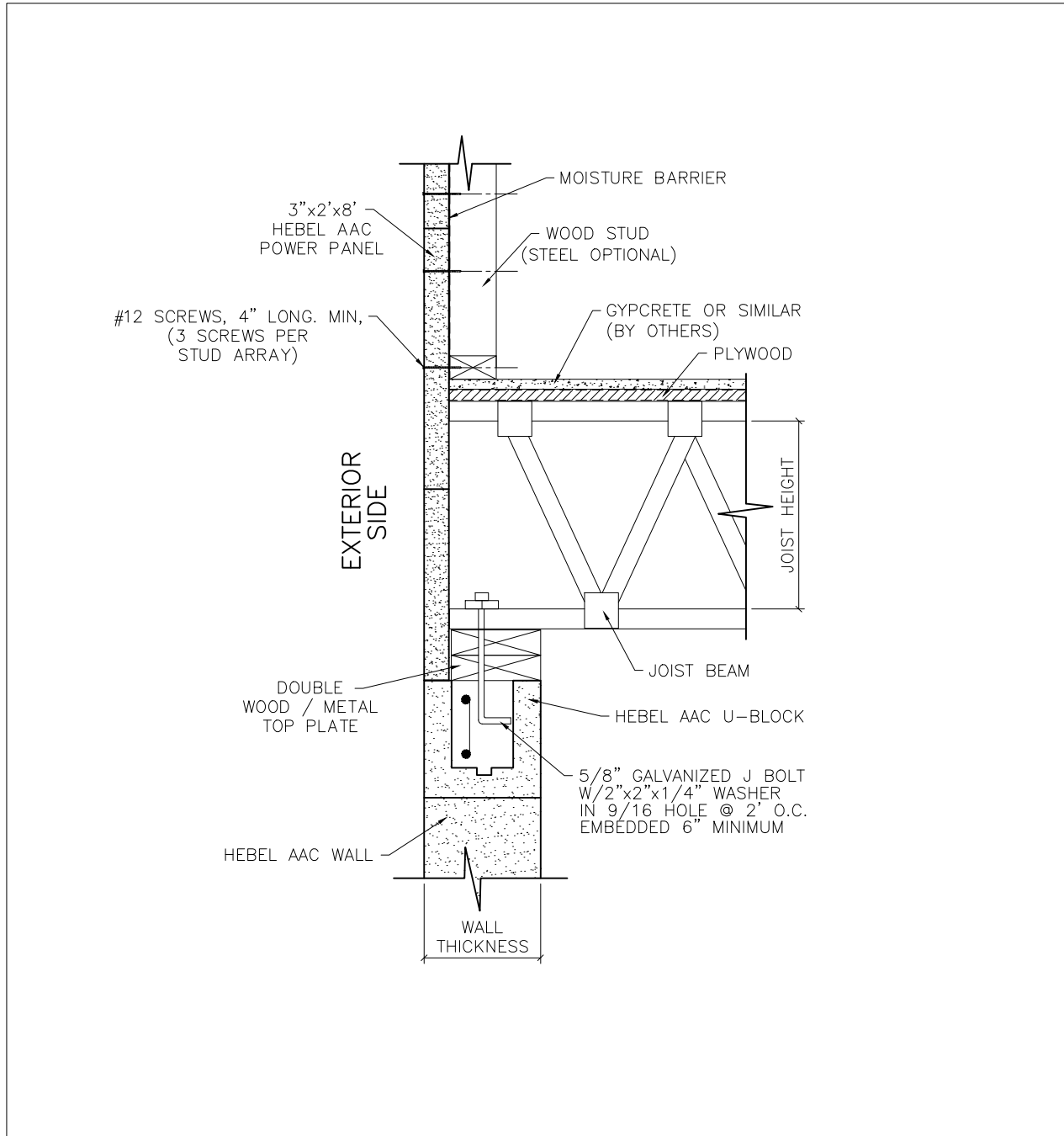

NOTES

- 1.-NOT SCALE
- 2.-DIMENSIONS IN INCHES
- 3.-SEE CEMENT BOARD TECHNICAL SHEET PROVIDED BY SUPPLIER (DIMENSIONS)
- 4.- USE SCREW TYPE DESKFAST #12

- 5.- SEE POWER PANEL INSTALLATION GUIDE TO CONNECT TO WOOD FRAMMING.

LITECRETE, S.A. DE C.V.

Río Amacuzac #1201 Ote. ■ Col. Valle Oriente ■ San Pedro Garza García, N.L. ■ México ■ 66269

Tel. +52 (81)8399-2464 +52 (81)8399-2462 Fax +52 (81)8399-2420

www.hebel.mx

September 2020